

THANK YOU FOR BUYING AN INDESIT PRODUCT

In order to receive a more complete assistance, please register your product on www.indesit.com/register



Before using the appliance carefully read the Safety Instruction.

Before using the machine, it is imperative that the transport bolts are removed. For more detailed instructions on how to remove them, see the Installation Guide.

CONTROL PANEL

1. ON/OFF button
2. START/PAUSE button with indicator light
3. WASH CYCLE PROGRESS indicator lights
4. DOOR LOCKED indicator light
5. FUNCTION buttons with indicator lights
6. DRYING ONLY button with indicator light
7. DRYING LEVELS button
8. TIME DRYING button
9. TEMPERATURE button
10. WASH CYCLE knob
11. PUSH & GO button

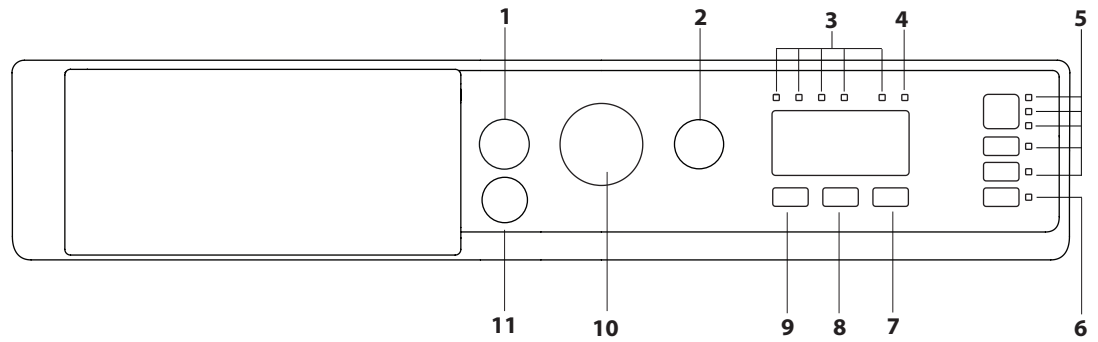

WASH CYCLE TABLE

Wash cycle		Temperature		Maximum spin (r.p.m.)	Maximum load for washing (Kg)	Duration (minutes)	Drying	Maximum load for drying (Kg)	Detergents and Additives		Recommended detergent	
		Default	Range						Wash	Fabric softener	Powder	Liquid
1	Mixed	40°C	☼ - 40°C	1000	3,5	59	●	3,5	●	○	-	✓
2	Cotton (2)	40°C	☼ - 60°C	1200	7	220	●	5	●	○	✓	✓
3	Synthetics	40°C	☼ - 60°C	1200	3,5	195	●	3	●	○	✓	✓
4	White	60°C	☼ - 90°C	1200	7	170	●	5	●	○	✓	✓
5	Coloureds	40°C	☼ - 40°C	1200	7	100	●	5	●	○	-	✓
6	Eco cotton ◻ (1)	60°C	☼ - 60°C	1200	7	215	●	5	●	○	✓	✓
7	Sport	40°C	☼ - 40°C	600	3,5	90	●	3,5	●	○	-	✓
8	Dark	30°C	☼ - 30°C	800	3	70	●	3	●	○	-	✓
9	Anti Odour	60°C	☼ - 60°C	1000	3	100	●	3	●	○	✓	✓
10	Delicates	30°C	☼ - 30°C	0	1	80	●	1	●	○	-	✓
11	Wool	40°C	☼ - 40°C	800	1,5	70	●	1,5	●	○	-	✓
12	Rapid 30 min	30°C	☼ - 30°C	800	3,5	30	-	3,5	●	○	-	✓
13	Wash&Dry 45 min	30°C	☼ - 30°C	1200	1	45	●	1	●	○	-	✓
14	AirFresh	-	-	-	-	30	●	1	-	-	-	-
	Rinse + Spin	-	-	1200	7	50	●	5	-	○	-	-
	Spin + Drain	-	-	1200	7	10	●	5	-	-	-	-

● Required dosage ○ Optional dosage

The cycle duration indicated on the display or instruction manual is an estimate based on standard conditions. The actual duration may vary in relation to several factors, such as the temperature and pressure of the incoming water, ambient temperature, amount of detergent, load quantity and type, load balancing and any additional options selected.

1) Test wash cycle in compliance with regulation EN 50229 (Wash):

This cycle is designed for normally soiled cotton loads and is the most efficient in terms of both electricity and water consumption; it should be used for garments washable at 60°C. The actual washing temperature may differ from the indicated value.

Test wash cycle in compliance with regulation EN 50229 (Drying):

Select the 6 wash programme and set the drying level to for both loads. The first drying cycle must be carried out with the nominal load.

For all testing institutes:

2) Long cotton cycle: set cycle 2 at a temperature of 40°C.

PRODUCT DESCRIPTION

1. Top
2. Detergent dispenser drawer
3. Control panel
4. Handle
5. Porthole door
6. Drain pump
7. Adjustable feet (4)

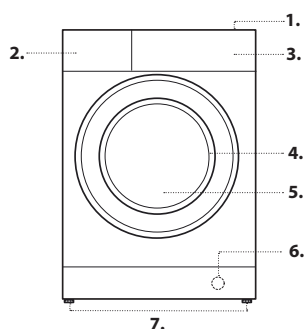

DETERGENT DISPENSER DRAWER

Compartment 1:

Do not insert detergent in this compartment.

Compartment 2: Washing detergent (powder or liquid)

Compartment 3: Additives (fabric softener, etc.)

The fabric softener must never exceed the "max" level indicated on the central pin.

! Use powder detergent for white cotton garments, for pre-washing, and for washing at temperatures over 60°C.

! Follow the instructions given on the detergent packaging.

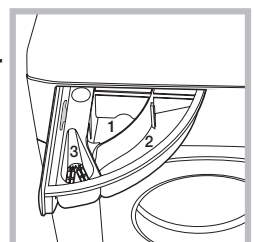

WASH CYCLES

Follow the instructions on the symbols of the garment's wash care label. The value indicated in the symbol is the maximum recommended temperature for washing the garment.



Mixed

For washing lightly to normally soiled resilient garments in cotton, linen, synthetic fibres and mixed fibres.

Cotton

Suitable for washing towels, underwear, table cloths, etc. made of resistant linen and cotton that are moderately to heavily soiled.

Synthetics

Suitable for washing moderately soiled garments made of synthetic fibres (e.g. polyester, polyacrylic, viscose, etc.) or mixed synthetic-cotton fibres.

White

For heavily soiled whites and resistant colours.

Coloureds

A 30°C cycle that helps to preserve colours, suitable for cotton or synthetic coloured garments. It allows for reducing electricity consumption for heating the water while guaranteeing good washing results. Suitable for lightly soiled garments.

Eco cotton

Suitable for washing moderately soiled cotton garments. At 60°C it is the standard cycle for washing cotton garments, and is the most efficient in terms of combined water and electricity consumption.

Sport

A cycle designed for washing lightly soiled sports clothing (tracksuits, shorts, etc.); for best results, we recommend not exceeding the maximum load indicated in the "Wash Cycle Table". We recommend using liquid detergent and adding the amount suitable for a half-load.

Dark

use programme to wash dark-coloured garments. This programme is designed to maintain dark colours over time. We recommend using a liquid detergent for the best results when washing dark-coloured garments.

When you select the drying function, at the end of the washing cycle the machine will automatically perform a delicate drying cycle that preserves the colours of the garments. The display will show the level "☁".

Max. load: 3 kg.

Anti Odour

use programme for washing garments with bad odours (e.g. smoke, sweat, fried food). The programme is designed to remove bad odours while preserving the fabric fibres. Synthetics fabrics or mixed loads should be washed at 40°, and resistant cotton fabrics at 60°.

Delicates

use programme to wash very delicate garments. It is advisable to turn the garments inside out before washing them. For best results, use liquid detergent on delicate garments.

When selecting an exclusively time-based drying function, a drying cycle is performed at the end of the wash cycle that is particularly delicate, thanks to light handling and appropriate temperature control of the water jet.

The recommended durations are:

1 kg of synthetic garments --> 150 min

1 kg of synthetic and cotton garments --> 180 min

1 kg of cotton garments --> 180 min

The degree of dryness depends on the load and fabric composition.

Wool - Woolmark Apparel Care - Blue:

The "Wool" wash cycle is approved by the Woolmark Company for washing wool garments classified as "hand-washable", provided that the wash complies with the instructions appearing on the garment's label and with those provided by the manufacturer of this washing machine (M1126).

Rapid 30 min

For washing lightly soiled garments in a short time. Not suitable for wool, silk and garments to be washed by hand.

Wash&Dry 45 min

select programme for washing and drying lightly soiled garments (Cotton and Synthetic) in a short time. This cycle may be used to wash and dry a laundry load of up to 1 kg in just 45 minutes. To achieve optimum results, use liquid detergent and pre-treat cuffs, collars and stains.

AirFresh

ideal cycle to refresh garments and remove bad odours, in particular smoke, from cotton and synthetic items in 30' (max 1.5kg) without the washing phase.

Rinse/ Bleach

Designed to spin and bleaching.

Spin + Drain

Designed to spin and drain the water.



WASH CYCLE PHASE INDICATOR LIGHTS

Once the desired wash cycle has been selected and has begun, the indicator lights switch on one-by-one to indicate which phase of the cycle is currently in progress.

- Wash
- Rinse
- Spin/Drain
- Drying

END End of Wash Cycle

DOOR LOCKED INDICATOR

When lit, the symbol indicates that the door is locked. To prevent any damage, wait until the symbol turns off before opening the door.

To open the door while a cycle is in progress, press the START/PAUSE button; if the indicator light is off, the door can be opened.

FIRST-TIME USE

Once the appliance has been installed, and before it is used for the first time, run a wash cycle with detergent and no laundry, by setting the "Auto-Clean" cycle.

DAILY USE

Prepare the laundry by following the suggestions appearing under the "TIPS AND SUGGESTIONS" section.

Rapid programming

- Open the door. Load the laundry while making sure not to exceed the maximum load quantity indicated in the cycle table.
- Pull out the detergent dispenser drawer and pour the detergent into the relevant compartments as described in "DETERGENT DISPENSER DRAWER section".
- Close the door.
- Press the PUSH & GO button to start the wash cycle.

Traditional programming

- Turn the washing machine on by pressing the ON/OFF button. All the indicator lights will light up for a few seconds, then only the lights corresponding to the settings for the selected wash cycle will remain lit; the START/PAUSE indicator light will also flash.
- Open the door. Load the laundry while making sure not to exceed the maximum load quantity indicated in the Wash Cycle Table.
- Pull out the detergent dispenser drawer and pour the detergent into the relevant compartments as described in "DETERGENT DISPENSER DRAWER" section.
- Close the door.
- Set the WASH CYCLE knob to the desired cycle.
- Modify the temperature: pressing the °C button allows for gradually reducing the temperature down to the cold wash level .
- Select the desired wash cycle.
- Select the desired options.
- Press the START/PAUSE button to start the wash cycle; the relative indicator light will light up steady green and the door will lock (indicator light on).

PAUSING A CYCLE

To pause the wash cycle, press the START/PAUSE button again; the indicator light will flash. If the indicator light is not lit, the door may be opened. To start the wash cycle from the point at which it was interrupted, press the START/PAUSE button again.

OPENING THE DOOR, IF NECESSARY

Once a cycle starts, the indicator light turns on to signal that the door cannot be opened. While a wash cycle is running, the door remains locked. To open the door while a cycle is under way, for example, to add or remove garments, press the START/PAUSE button to pause the cycle; the indicator light will flash. If the indicator light is not lit, the door may be opened. Press the START/PAUSE button again to continue the cycle.

CHANGING A RUNNING WASH CYCLE

To change a wash cycle while it is in progress, pause the washing machine using the START/PAUSE button (the relative indicator light will flash), then select the desired cycle and press the START/PAUSE button again.

! To cancel a cycle that has already begun, press and hold the ON/OFF button.

The cycle will be stopped and the machine will switch off.

END OF THE CYCLE



Once the cycle terminates the **END** indicator light will light up; when the indicator light switches off, the door may be opened. Open the door, unload the laundry and switch off the machine. If you do not press "ON/OFF" button, the washing machine will switch off automatically after about a half of an hour. Close the water tap, open the door and unload the washing machine. Leave the door ajar to allow the drum to dry.

FUNCTIONS

- If the selected option is not compatible with the set wash cycle, the indicator light will flash and the option will not be activated.
- If the selected option is not compatible with another previously selected option, the indicator light will flash accompanied by a buzzer, and only the latter option will be activated; the indicator light corresponding to the activated option will turn on.

Stain removal

This option allows for selecting the type of dirt so as to optimally adjust the cycle for removing the stains. The following types of dirt can be selected:

-  **Food:** for stains caused by foodstuffs and beverages, for example.
-  **Work:** for grease and ink stains, for example.
-  **Outdoor:** for mud and grass stains, for example.

! The wash cycle duration varies according to the type of selected dirt.

Slow Spin

By selecting this function, reduces the spin speed.

Extra rinse

By selecting this option, the efficiency of the rinse is increased and optimal detergent removal is guaranteed. It is particularly useful for sensitive skin.

Temperature

Each wash cycle has a pre-defined temperature. To modify the temperature, press the  button.

Bleaching

If you wish to bleach the laundry, load the washing machine and set the programme .

Start the machine and wait for it to complete the first water filling cycle (roughly 2 minutes). Put the machine in pause mode by pressing the "START/PAUSE" button , open the detergent drawer and pour the bleach (observe the recommended doses indicated on the package) into the wash compartment where the partition was previously mounted.

Restart the cycle by pressing the "START/PAUSE" button .

If desired, it is possible to add fabric softener into the appropriate compartment of the detergent drawer.

Drying

Drying may be set as follows:

 - Based on the desired laundry dryness level:

Iron : suitable for clothes which will need ironing afterwards. The remaining dampness softens creases, making them easier to remove.

Hanger : ideal for clothes which do not need to be dried fully.

Cupboard : suitable for laundry which can be put back in a cupboard without being ironed.

 - Based on a set time period: between **40** and **180** minutes.

If your laundry load to be washed and dried is much greater than the maximum stated load, perform the wash cycle, and when the cycle is complete, divide the garments into groups and put some of them back in the drum. At this point, follow the instructions provided for a "**Drying only**" cycle. Repeat this procedure for the remainder of the load. A cooling-down period is always added to the end of each drying cycle.

Drying only



Press button  to perform the drying-only cycle.

After selecting the desired cycle (compatible with the type of garments), press button  to exclude the washing phase and start the drying phase at the maximum level for the selected cycle.

Push & Go

This function makes it possible to start an automatic wash and drying cycle either when the machine is off without having to press the ON/OFF button in advance, or after switching on the machine without having activated any button and/or selector (otherwise the Push & Go function will be deactivated). To start the Push & Go cycle press and hold the button for 2 seconds. The indicator lights up to show that the cycle has started. The wash and drying cycle is ideal for cotton or synthetic fabrics, as it washes them at a temperature of 30° and a maximum spin speed of 1000 rpm. During the drying cycle the maximum temperature is 60°C. At the end of the cycle the residual humidity will be the same as for the  level. Max recommended load 3,5 kg. (Cycle duration 210').

How does it work?

1. Load the laundry (cotton and/or synthetic garments) and close the door.
2. Pour the detergent and/or additives.
3. Start the cycle by pressing and holding the Push & Go button for 2 seconds. The relevant indicator light will turn green and the door will lock (the DOOR LOCKED symbol is lit).
NB: starting the cycle through the Push & Go button activates an automatic non-customisable wash and drying cycle recommended for cotton and synthetic fabrics.
4. The automatic cycle can be used only for washing, excluding the drying phase. Press the Push & Go button and then the drying button : the drying icon of the  level will switch off. Maximum load for washing-only is 4 kg (Cycle duration 45'). The cycle cannot be customised further. To open the door while an automatic cycle is under way, press the START/

PAUSE button. If the DOOR LOCKED symbol is off, the door may be opened only during the washing phase. Press the START/PAUSE button again to restart the wash cycle from the point at which it was interrupted. 5. Once the programme is finished, the **END** indicator light turns on.

TIPS AND SUGGESTIONS

Divide the laundry according to:

Type of fabric (cotton, mixed fibres, synthetics, wool, garments to be hand-washed). Colour (separate coloured garments from whites, wash new coloured garments separately). Delicates (small garments – such as nylon stockings – and items with hooks – such as bras: insert them in a fabric bag).

Empty the pockets:

Objects such as coins or lighters can damage the washing machine and the drum. Check all buttons.

CARE AND MAINTENANCE

Before performing cleaning and maintenance, switch the washing machine off and disconnect it from the mains power. Do not use flammable liquids to clean the washing machine.

Disconnect the water and power supplies

Close the water tap after every wash. This will limit wear on the hydraulic system inside the washing machine and help to prevent leaks. Unplug the washing machine when cleaning it and during all maintenance work.

Clean the washing machine

The outer parts and rubber components of the appliance can be cleaned using a soft cloth soaked in lukewarm soapy water. Do not use solvents or abrasives.

The washing machine has a "Auto-clean" cycle for its internal parts; it must be run without any load in the drum.

To optimise this cycle, it is possible to use either detergent (10% of the quantity specified for lightly soiled garments) or special additives to clean the washing machine. We recommend running a cleaning cycle every 40 wash cycles.

To start the cycle press buttons  and  simultaneously for 5 seconds.

The cycle will start automatically and will run for about 70 minutes. To stop the cycle, press the START/PAUSE  button.

Clean the detergent dispenser drawer

Wash it under running water; this operation should be repeated frequently.

Care for the door and drum

Always leave the porthole door ajar in order to prevent unpleasant odours from forming.

Clean the pump

The washing machine is fitted with a auto-cleaning pump that does not require any maintenance. Small items (such as coins or buttons) may sometimes fall into the protective pre-chamber situated at the base of the pump.

! Make sure the wash cycle has ended and unplug the appliance.

To access the pre-chamber:

1. loosen the drainage pump cover by turning it anti-clockwise: it is normal for some water to leak out;
2. clean the inside thoroughly;
3. screw the cover back on;

Check the water inlet hose

Check the water inlet hose at least once a year. If it is cracked or broken, it must be replaced: during wash cycles, the high pressure of the water could suddenly split the hose open.

! Never use hoses that have already been used.

LOAD BALANCING SYSTEM

Before every spin cycle, to avoid excessive vibrations before every spin and to distribute the load in a uniform manner, the drum rotates continuously at a speed which is slightly greater than the washing rotation speed. If, after several attempts, the load is not balanced correctly, the machine spins at a reduced spin speed. If the load is excessively unbalanced, the washing machine performs the distribution process instead of spinning. To encourage improved load distribution and balance, we recommend small and large garments are mixed in the load.



TRANSPORT AND HANDLING

Do not lift the washing machine by gripping it from the upper section.

Unplug the appliance and close the water tap. Check that the door and detergent dispenser drawer are tightly closed. Detach the filling hose from the water tap then detach the drain hose. Empty all the water remaining in the hoses and secure the latter so that they do not get damaged during transport. Apply the transport bolts back on. Repeat, in reverse order, the transport bolt removal procedure described in the "Health & Safety and Installation Guides".

TROUBLESHOOTING

The washing machine may occasionally fail to work. Before contacting the Technical Assistance Service, make sure that the problem cannot be easily solved using the following list.

Anomalies	Possible causes / Solution
The washing machine does not start.	The appliance is not plugged into the socket, or not sufficiently to make contact.
	There is no power in the house.
The wash cycle does not start.	The washing machine door is not closed properly.
	The ON/OFF  button has not been pressed.
	The START/PAUSE  button has not been pressed.
	The water tap has not been opened.
The machine does not fill with water or the indicator light for the first wash cycle stage flashes rapidly.	A delay has been set for the start time.
	The water inlet hose is not connected to the tap.
	The hose is bent.
	The water tap has not been opened.
	There is no water supply in the house.
	The pressure is too low.
The washing machine continuously loads and unloads water.	The START/PAUSE  button has not been pressed.
	The drain hose is not fitted between 65 and 100 cm from the floor.
	The free end of the hose is immersed in water.
	The wall drainage system does not have a breather pipe. If the problem persists even after these checks, turn off the water tap, switch the appliance off and contact the Technical Assistance Service. If the home is on one of the upper floors of a building, there may be problems relating to back-siphonage, causing the washing machine to fill with water and drain continuously. Special anti-siphon valves are available in shops and help to prevent this inconvenience.
The washing machine does not drain or spin.	The cycle does not include drainage: with certain cycles it must be started manually.
	The drain hose is bent.
	The drainage duct is clogged.
The washing machine vibrates a lot during the spin cycle.	The drum was not unlocked correctly during installation.
	The washing machine is not level.
	The washing machine is tucked between furniture cabinets and the wall.
The washing machine leaks.	The water inlet hose is not screwed on properly.
	The detergent dispenser drawer is obstructed.
	The drain hose is not properly attached.
The "Options" lights and the START/PAUSE indicator light flash while one of the wash cycle progress and DOOR LOCKED lights are lit in a fixed manner.	Switch off the machine and unplug it, wait for approximately 1 minute and then switch it back on again. If the problem persists, contact the Technical Assistance Service .
There is too much foam.	The detergent is not suitable for machine washing (it should be marked with "for washing machine use" or "hand wash and machine wash" or similar).
	Too much detergent was used.
The Push & Go function does not activate.	After switching on the machine, a control other than Push & Go was activated. Switch the machine off and press the Push & Go button.
The washer-dryer does not dry.	The appliance is not plugged into the socket, or not enough to make contact.
	There has been a power failure.
	The appliance door is not shut properly.
	All the drying indicator lights are off.



You can download the Safety Instructions, User Manual, Product Fiche and Energy data by:

- Visiting our website - <http://docs.indesit.eu>
- Using QR Code
- Alternatively, **contact our echnical Assistance Service** (See phone number in the warranty booklet). When contacting our After-sales Service, please state the codes provided on your product's identification plate.

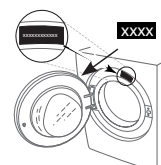

11310934